

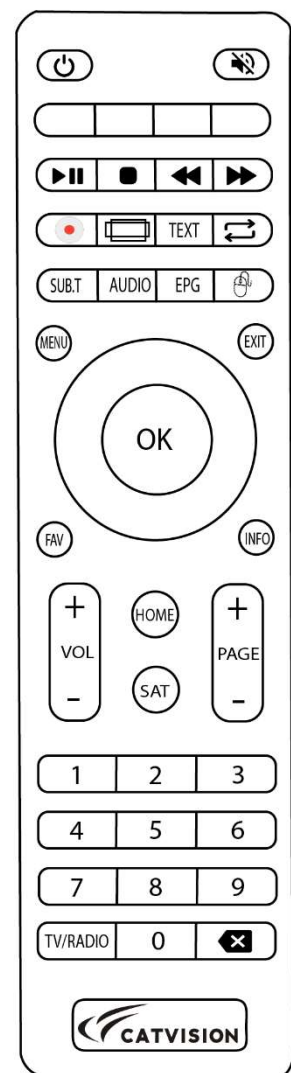

Hybrid Set Top STB

Model: CHA-501S2
(OTT+DVB-S2)

User Manual

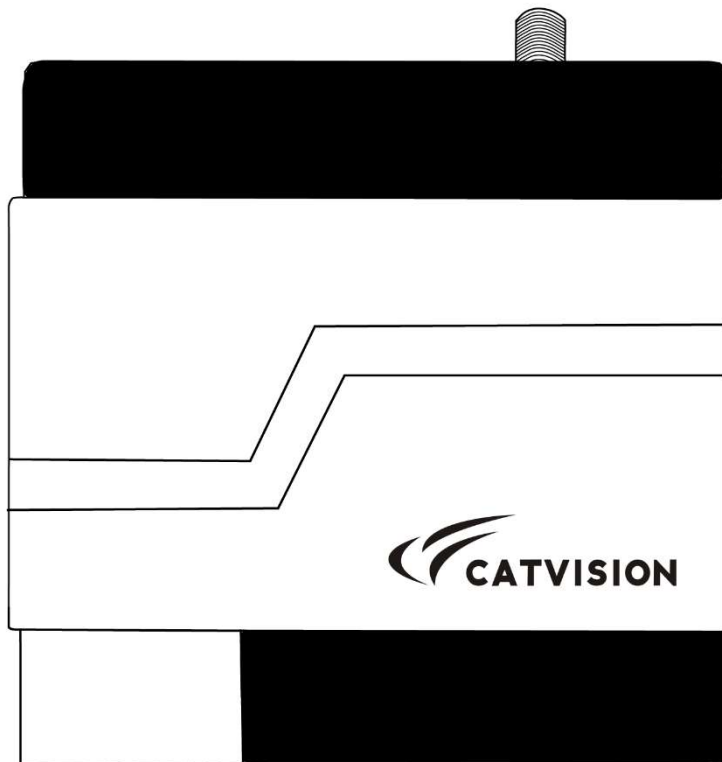

CATVISION LIMITED

E-14&15, Sector-8, Noida - 201301 (U.P.) India
email: info@catvisionindia.com
website: www.catvisiononline.in

Introduction

Congratulations on your purchase of Catvision's Hybrid Set Top Box! This user manual will guide you through the setup process and provide essential information about the features and functionality of your new device. Please read this manual carefully to ensure optimal performance and enjoyment of your hybrid STB.

Main Features:

1. **DVB-S2 FTA Channel Support:** The hybrid STB is designed to support DVB-S2 Free-to-Air (FTA) channels, allowing you to access a wide range of television channels *without any payment*. By default it is tuned to Doordarshan's Free Dish service from satellite.
2. **Android 10 with AOSP TV:** Powered by Android 10 and AOSP TV, the hybrid STB offers a user-friendly interface and access to a vast ecosystem of Android OTT apps like Netflix, Disney+Hotstar, Sony LIV, Jio Cinema, Prime Video, YouTube and more, providing a seamless entertainment experience.
3. **4K+HDR Video Playback:** Enjoy stunning 4K resolution and HDR (High Dynamic Range) support on compatible TVs or displays, delivering exceptional clarity, colour, and contrast.
4. **Multiple Connectivity Options:** With 3 USB ports, SD/MMC Card, AV and HD ports, the hybrid STB offers versatile connectivity options for connecting external devices and peripherals.
5. **Ample Storage and Memory:** Featuring 2 GB of RAM and 16 GB of storage, the hybrid STB offers sufficient space for storing apps, media files, and other content.
6. **Connectivity:** The hybrid STB supports both 2.4GHz and 5GHz Wi-Fi frequencies for stable and fast wireless connectivity of streaming and online content. It is also equipped with an Ethernet port allowing you to establish a wired internet connection for reliable and high-speed data transfer. It is equipped with Bluetooth 4.0 for connecting Bluetooth-supported devices.
7. **Easy Installation and Setup:** The hybrid STB is designed for easy installation and setup. Simply connect it to your TV, follow the on-screen instructions, and start enjoying your favourite channels and apps in no time.
8. **Remote Control Convenience:** The hybrid STB comes with a user-friendly IR remote control, allowing you to navigate menus, select channels, mouse mode to navigate, adjust settings and control playback with ease. Also, you can connect to a Bluetooth remote.
9. **Software Updates:** Stay up-to-date with the latest features and improvements through regular software updates provided for the hybrid STB, ensuring a consistently optimized and enjoyable user experience.

Note: The features mentioned may vary slightly based on the specific model or version of the hybrid STB.

Safety Precautions

Warning:

- Do not use this STB where contact with or immersion in water is a possibility. Do not use near flower vase, washbowls, kitchen sinks, laundry tubs, swimming pools, etc.
- Do not put a candle or lamp stand on top of the STB; otherwise, there is a danger of fire.
- The unit should be connected to a power supply only of the type described in the operating instructions or as marked on the unit. If you are not sure of the type of power supply (for example, 120 or 230 V) to your home. The output specification of power adaptor is 12V~1 AMP.
- This product contains sensitive electronic components; do not open cabinet and touch inside. Consult your local dealer for technical service if opening of the STB is required.

Unit Cleaning: After the unit power is turned off, you can clean the cabinet, panel and remote control with a soft cloth lightly moistened with a mild detergent solution.

Attachments: Never add any attachments and/or equipment without the manufacturer's consent; such additions may result in the risk of fire, electric shock, or other personal injury.

Location: Slots and openings in the cabinet are provided for ventilation to protect the STB from overheating. Do not block these openings or allow them to be blocked by placing the STB on a bed, sofa, or other similar surface, nor should it be placed over a radiator or heat blower.

Power-Cord Protection: Place the power-supply cord out of the way, where it will not be walked upon. Please pay special attention to cords at plugs, convenience receptacles, and the point where they exit from the unit.

Object and Liquid Entry: Never put objects of any kind into this STB through openings, as it may touch dangerous points or short-circuit parts that could result in electric shock. Never spill any liquid in the STB.

Parts Replacement: When the STB needs to be repaired the user should make sure that this STB is serviced by the manufacturer or authorized service centre. Use only the manufacturer-specified spares to avoid electric shock or any other hazards.

Safety Check: After all the maintenance and repairs are done, user should request the service technician to conduct the overall safety check to ensure that the machine is in the proper condition.

Hybrid STB Connection Diagram

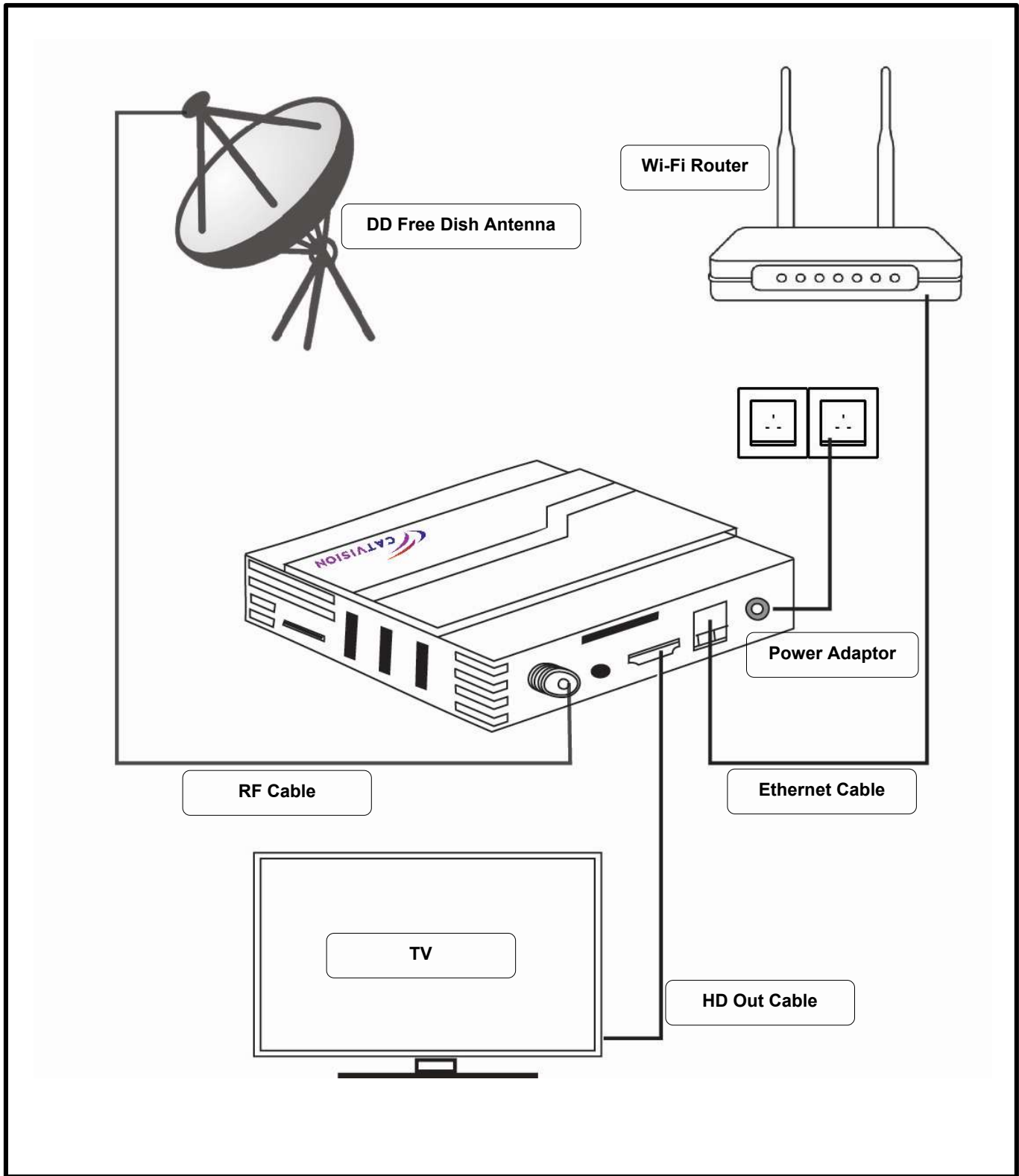

Remote Control Operation

Remote control

- 1 Standby**
 - Press [Standby] key for the STB to Reboot/Shutdown/enter the Standby state.
- 2 Mute**
 - Press [Mute] key to mute/unmute the sound.
- 3 Media Control**
 - Play/Pause: Press this button to Play/Pause the video.
 - Stop: Press this button to stop the video.
 - Backward/Forward: Press this button to seek backward/forward the video.
 - Record: In DTV player, press this button to record the live channel.
 - Aspect Ratio: Press this button to adjust screen size.
 - Text: In DTV player, press this button to show teletext if available. Recall: Press this key to switch to the last viewed channel
 - Sub.T: In DTV player, press this button to show Subtitles, if available.
 - Audio: In DTV player, press this button to change audio settings.
 - EPG: In DTV player, press this button to show EPG information if available

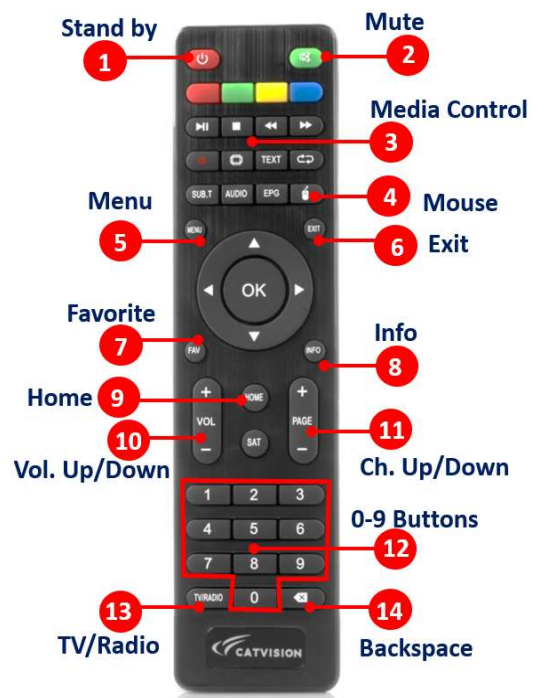

- 4 Mouse ICON**
 - Press this button to move the cursor on screen.
- 5 MENU**
 - In DTV Player, press this button to show menu option.
- 6 EXIT**
 - Press [EXIT] key to exit the current menu to last menu or close the window.
- 7 FAV**
 - In DTV player, press this key to call up the Favourite Channel Group List.
- 8 INFO**
 - In DTV Player, press this key to get information about the channel and it's corresponding satellite details.
- 9 HOME**
 - press this key to display STB home screen.
- 10 VOL +/-**
 - press this key to adjust the volume.
- 11 CH +/-**
 - In DTV player, press this key to change channel.
- 12 Number Keys**
 - In DTV Player, use number key and press [OK] on the Remote Control Unit to change channel.
- 13 TV/Radio**
 - Pressing [TV/RADIO] key can switch to TV/Radio mode.
- 14 Backspace**
 - Press this key to delete the typed character.

Installation

After powering up your TV or monitor it will initially display an animated “Catvision” logo while loading. When loading is complete, the display will enter the setup screen.



1. Select the Language (Note: English is default language)

Select Next with your remote.

2. Select your time zone (Note: Asia/Calcutta GMT+5:30 is default).

Select Next with your remote.

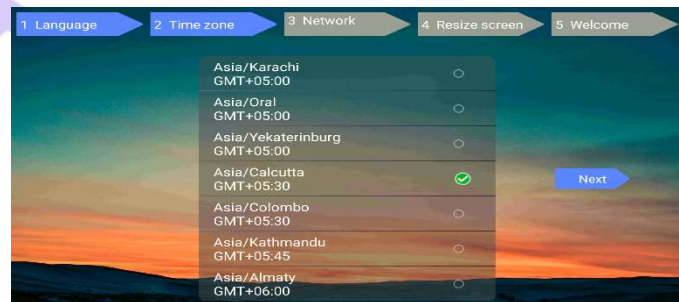

3. Connect with Wi-Fi network or skip if Internet connection is not available.

Select Next/Skip with your remote.



4. Press Left & Right key for Zoom Out/In to adjust screen size.

Select Next with your remote.

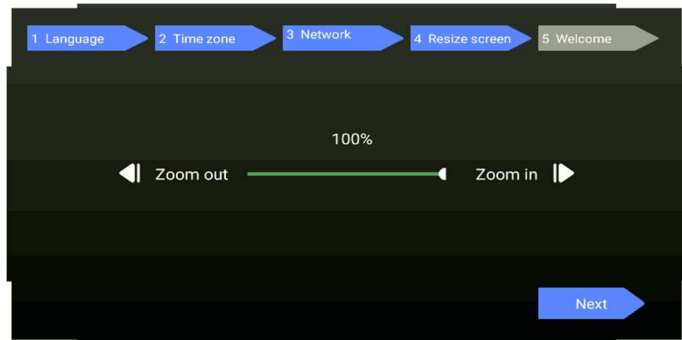

5. This slide shows the image of remote control unit (RCU).

Select Finish with your remote.

You have now finished setting up your unit for the first time. Now, let's take you through the menus.

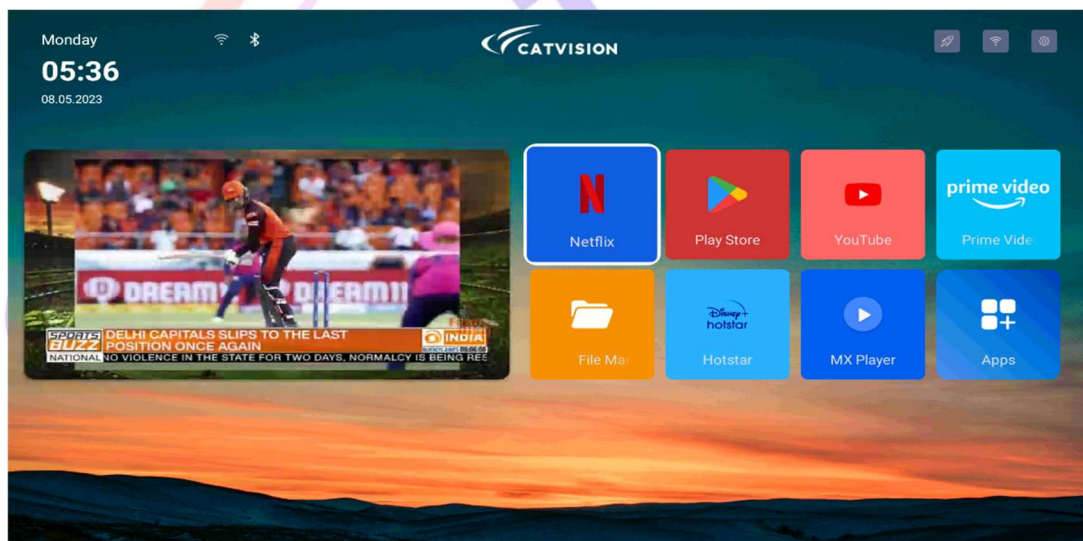

How to set up the Wi-Fi connection

1. Select the Wi-Fi icon on the top right side on your TV then press OK on your remote.

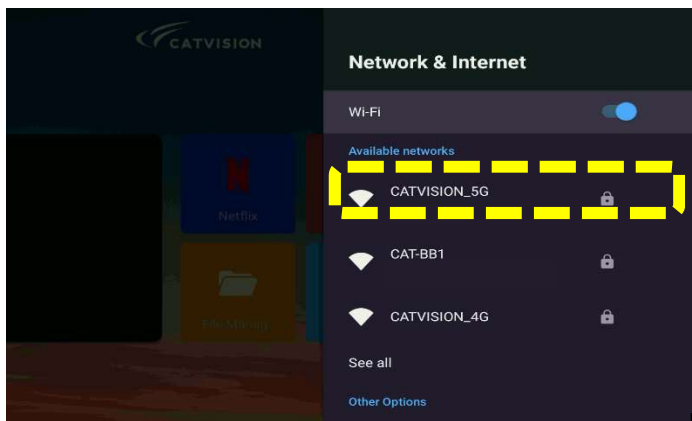
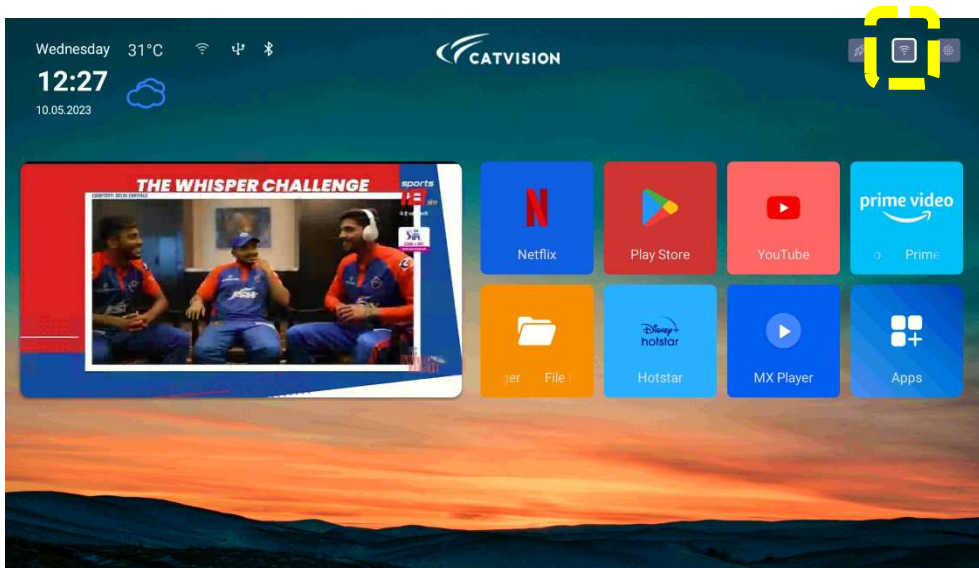

2. Select Wi-Fi SSID available at your location then press OK on your remote.

2. Enter your Wi-Fi password then select the 'enter' button showing on your screen and press OK on your remote.

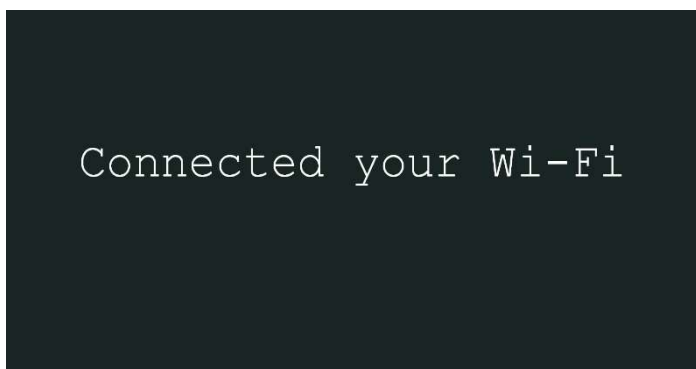
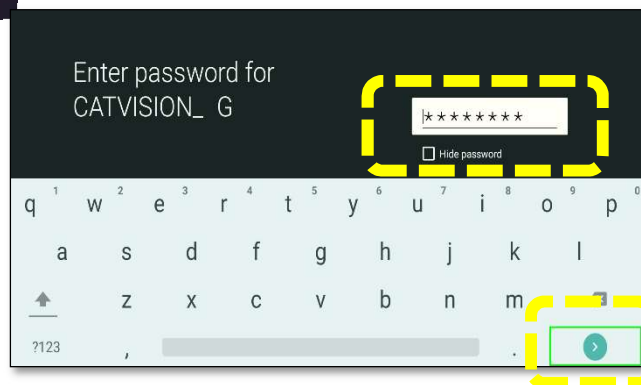

3. Congratulation! You have successfully connected.

How to sign in to Google Play Store

Open the Play Store and sign in with your Google ID. Now you can install apps and receive regular updates.

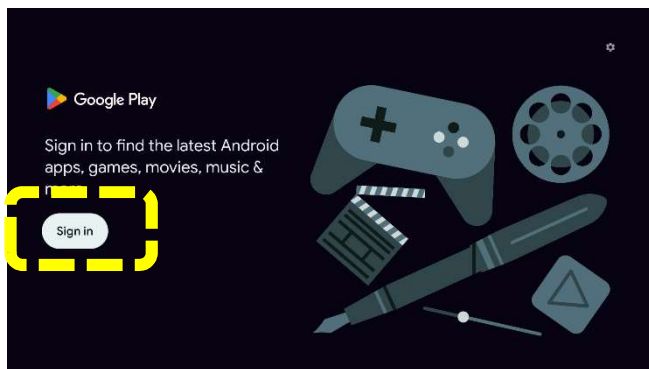
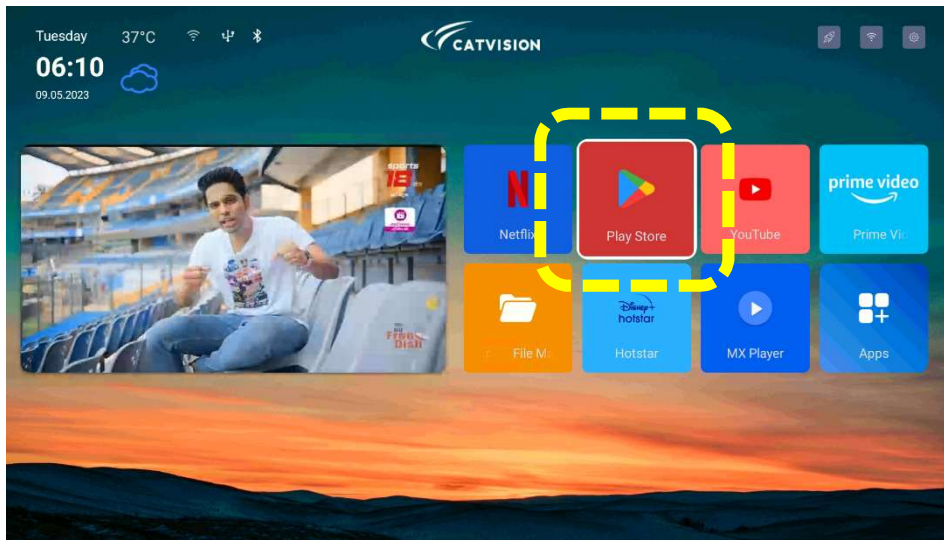

1. Click on Sign In button

2. Enter your Google login credentials.

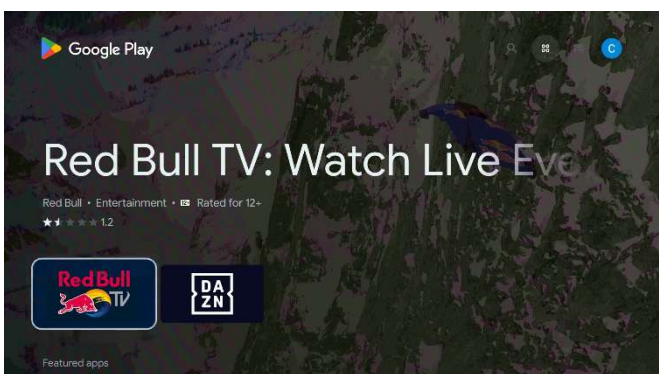
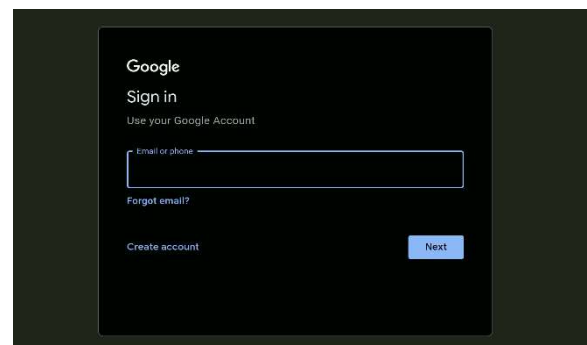

3. You have successfully logged in your account. Search your favourite app in search bar and install.

How to set up DTV Player manually for DD Free Dish

The DTV player is already pre-tuned to the DD Free Dish satellite. If, for any reason, the DTV player gets un-tuned, it can be re-tuned manually.

1. Open DTV Player App.

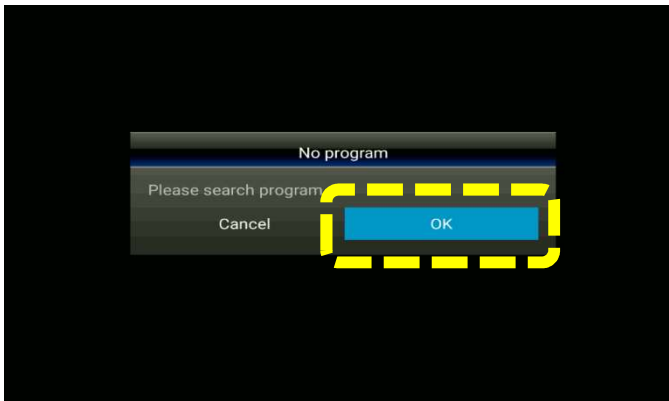
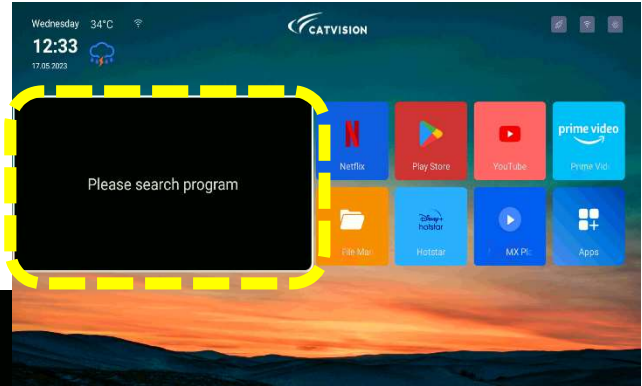

2. Select OK then press ok on your remote.

3. Select Direction 095.0 E then press SAT key (2) on your remote.

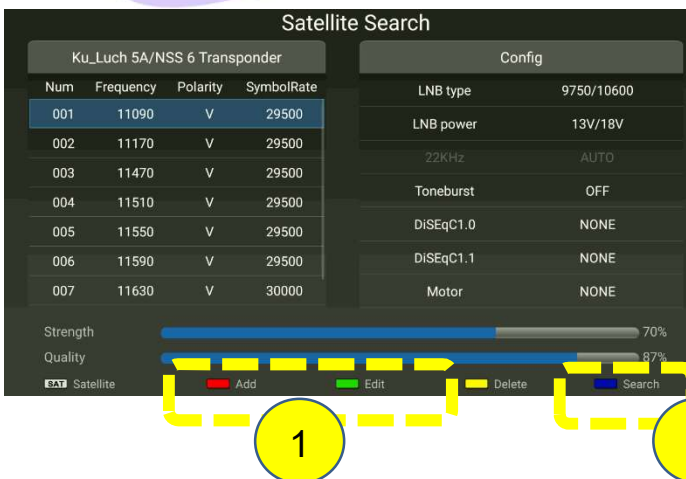
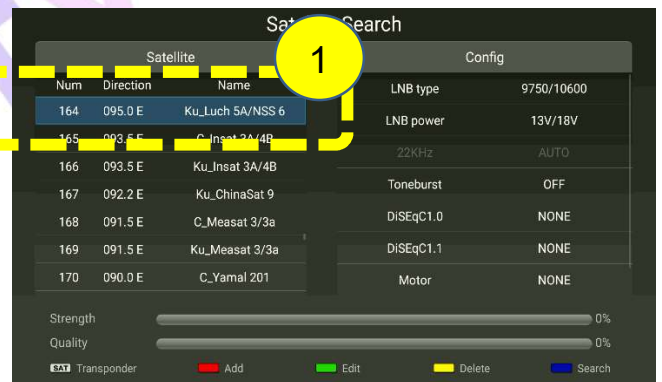

4. After pressing SAT key add or edit Frequency, Polarity, Symbol Rate with the red or green hot key.

Num	Frequency	Polarity	Symbol Rate
001	11090	V	29500
002	11170	V	29500
003	11470	V	29500
004	11510	V	29500
005	11550	V	29500
006	11590	V	29500
007	11630	V	30000
008	11670	V	29500

After adding or editing all the frequencies press blue hot key to search channels

3. After pressing blue hot key change Scan mode to Default, Crypted to FTA channels and Service type to All, then click OK.

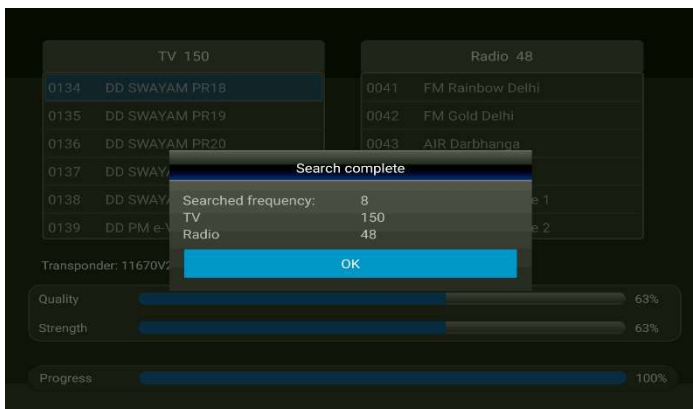
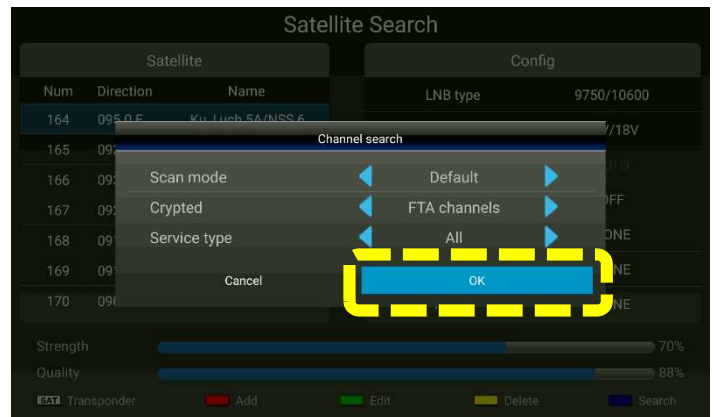

4. Wait for few minutes for scanning of all channels to be completed then press OK to play TV/Radio channels.

CATVISION

How to setup DTV Player for DD Free Dish using backup file

1. <https://www.catvisiononline.in/all-apps> (DTV App Backup→ For Hybrid Box)
2. Open DTV Player to for DD Free Dish channels.

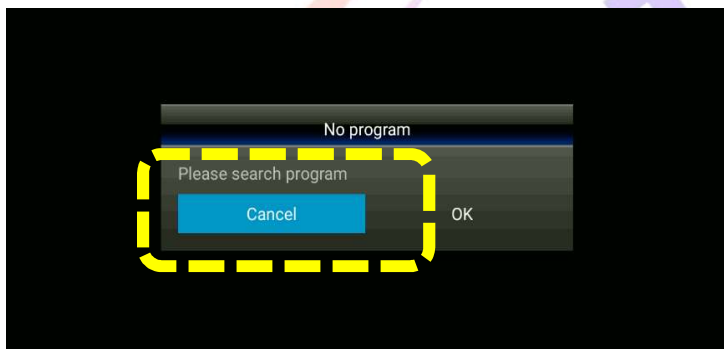
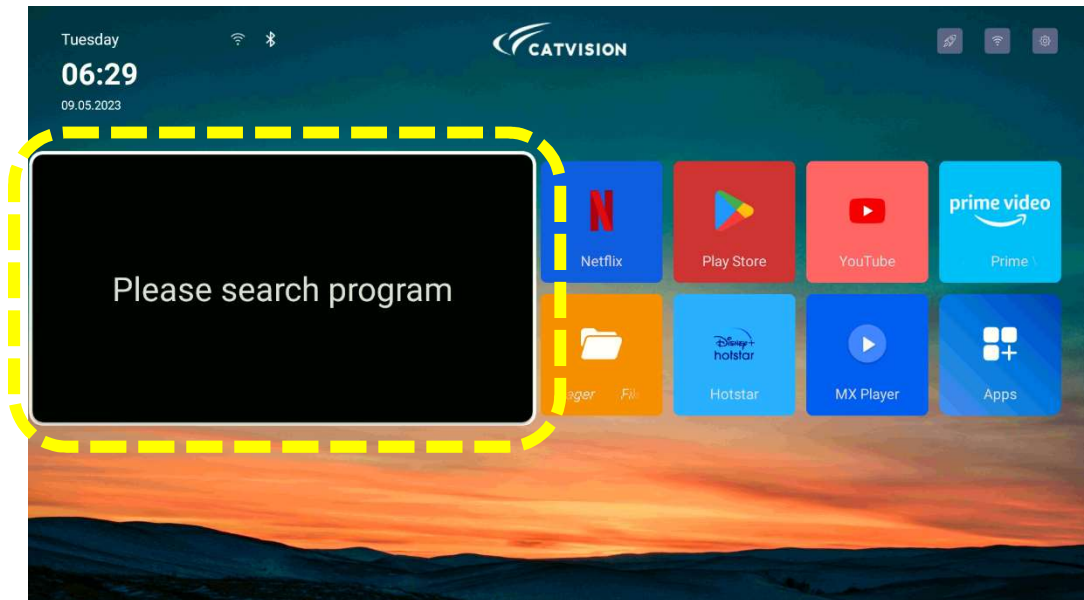

1. Select "Cancel" then press OK on remote.

2. "No program" screen shows on your TV. Press Menu on your remote.



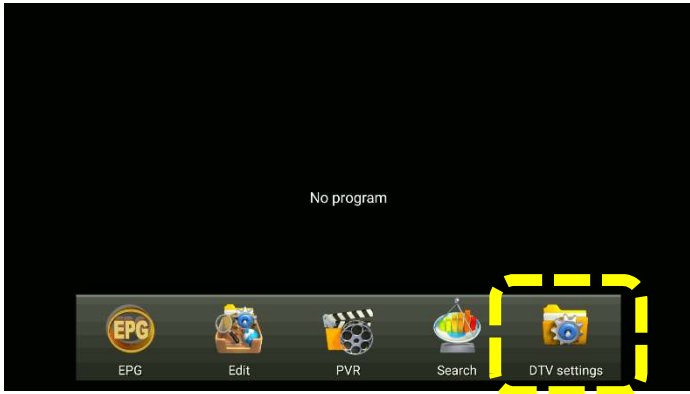

3. Select “DTV settings” then press OK on your remote.

4. Select Backup & reset → Recovery. then press OK on your remote.

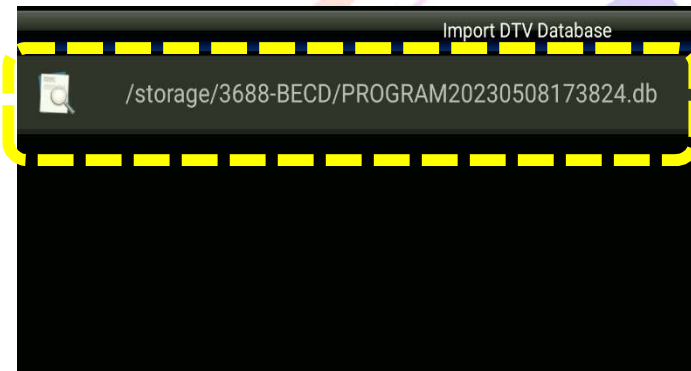
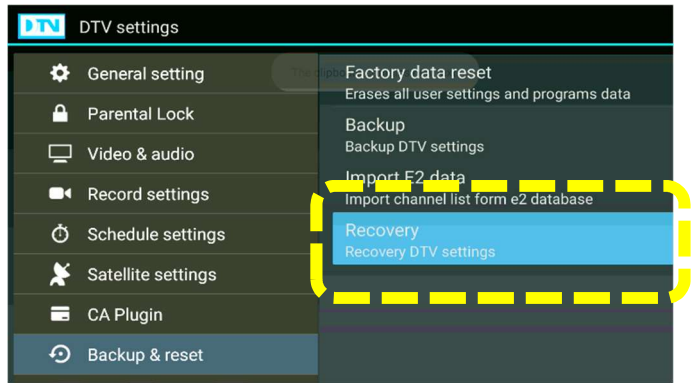

5. Select backup file (programxxxx.db) from your USB drive then press OK on your remote.

(Note: USB drive/Pen drive is required for storing the backup file.)

6. Wait for a moment until the TV screen shows Recovery success. Now you can watch DD Free Dish channels.

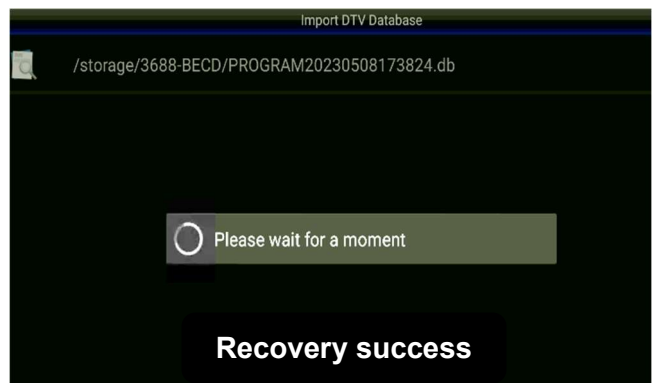

How to record live channels and watch (PVR)

**To record live channels a USB drive or Pen drive is required.*



1. Plug the USB drive/Pen drive to your Hybrid STB then press “Record” button on your remote.

2. Recording window will appear Top Right on your TV.

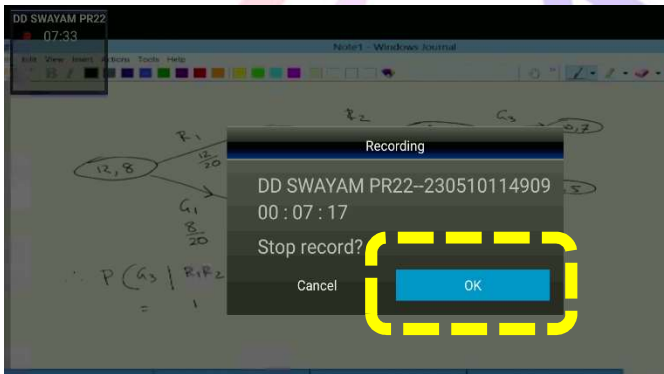
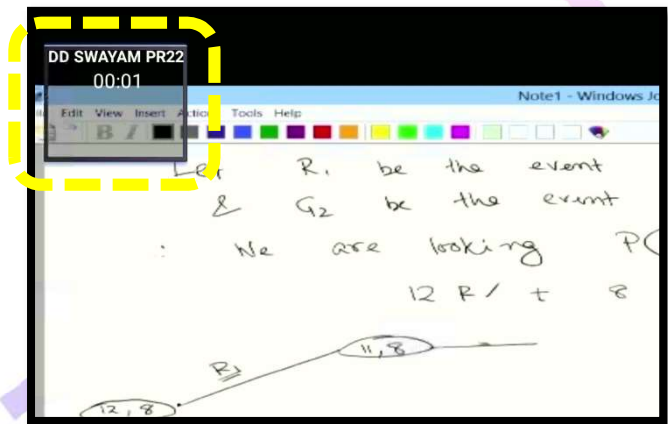

3. To stop or pause recording press Record button then select “OK”.

4. To play recording press Menu button on your remote then select “PVR” option then press OK on your remote.

**Ensure that USB drive/Pen drive is plugged on your STB.*

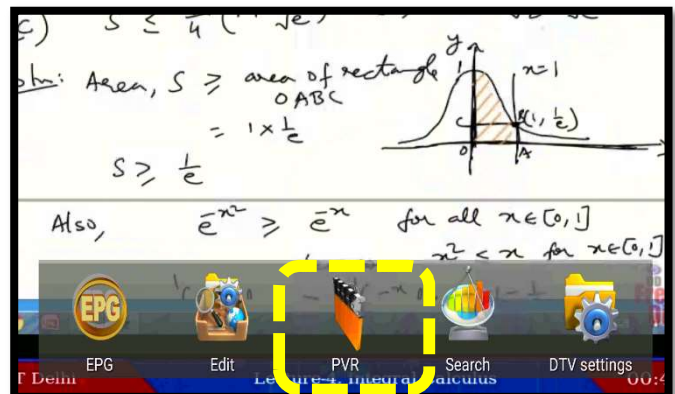



5. Select recorded file then press OK on your remote to play.

6. Now you can watch your recorded live channels. You can forward or backward your video with the help of left or right arrow button on your remote.

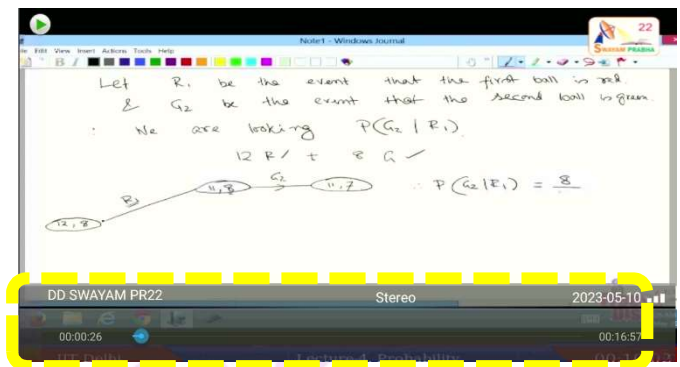

CATVISION LIMITED

E-14&15, Sector-8, Noida - 201301 (U.P.) India

email: info@catvisionindia.com

website: www.catvisiononline.in

Toll Free No – 7669300112

(09:00 am to 06:00pm)